

auto electrical parts

Technical Information Sheet

Part No. 0-605-52

Durite's Single Pole Single Throw On/Off Isolator with removable handle. Used for isolating vehicle battery's. 24VDC Max. 250A Continuous. 2150A Max for 5 Seconds. M10 Terminals Tightening Torque 1.5+/- 0.1 daNm. Copper Contacts. Connections not polarized. Protected to IP54.



Technical Drawing (not to scale)

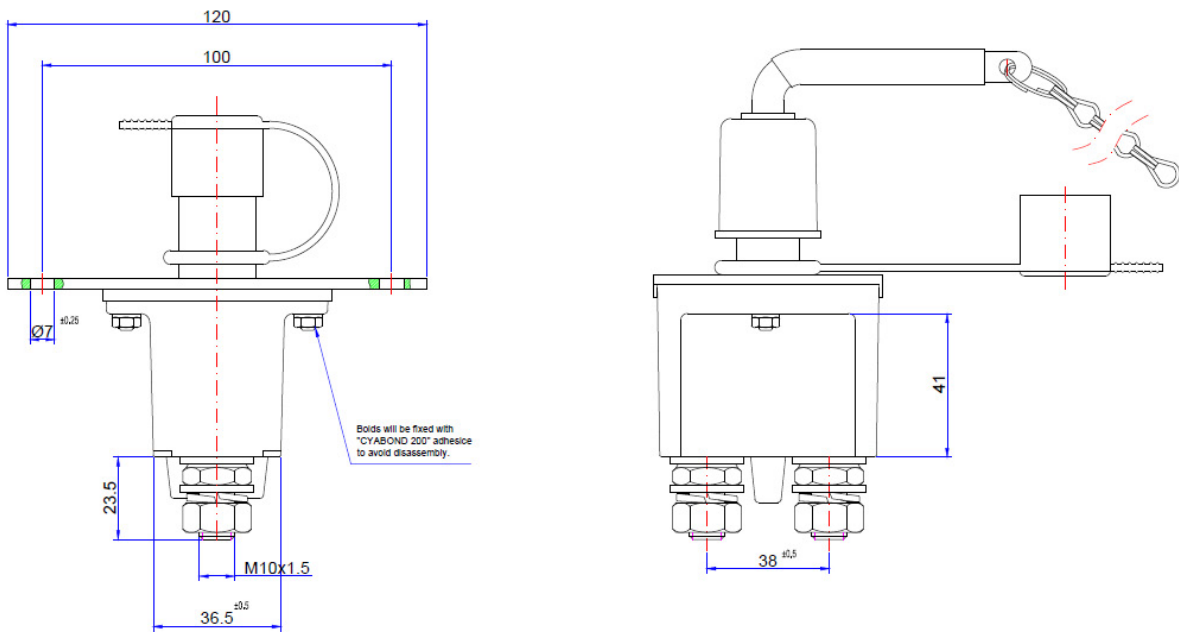

Specification

Volts	24 VDC Max
Amps	250A Continuous. 2150A Max for 5 Seconds
Type	D1 Normally Open
Studs	2 x M10
Stud Tightening Torque	1.5+/- 0.1 daNm
Contacts	Copper
Connections	Not Polarized
Protection	IP54
Weight	0.6Kg
Operating Temperature	-40C - +85C
Certificate	n/a
Dimensions	Please see above (dimensions in mm)

The information contained in this document is correct to the best of our knowledge at the time of printing. However, specifications may change at any time without notice.